

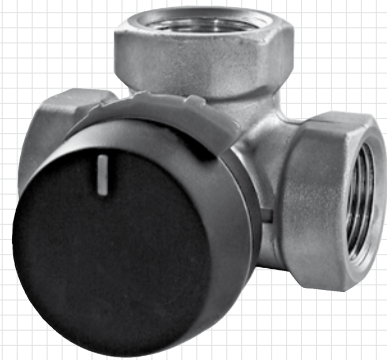

www.esbe.se



### SERIES VRG130



NO.1 IN HYDRONIC SYSTEM CONTROL



Series VRG131

CE

Pressure Equipment Directive 97/23/EC

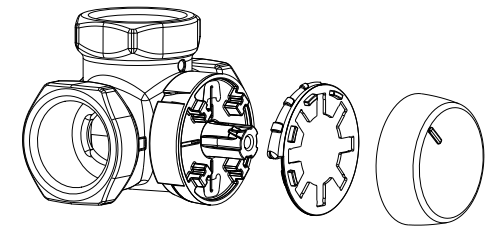
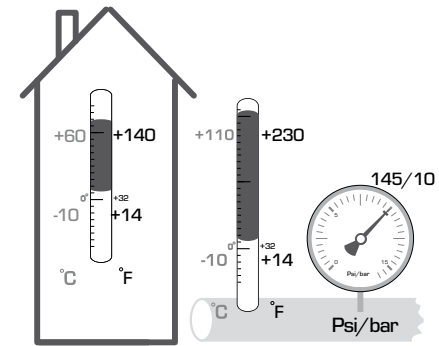

1a

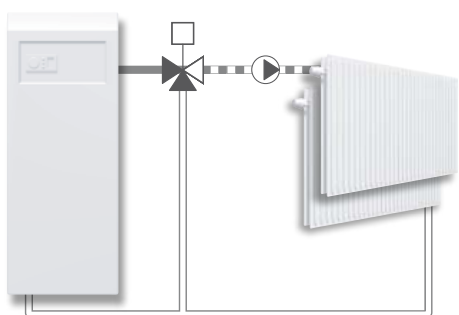
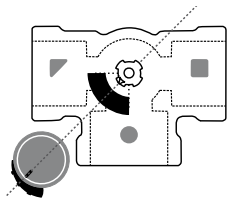

1b

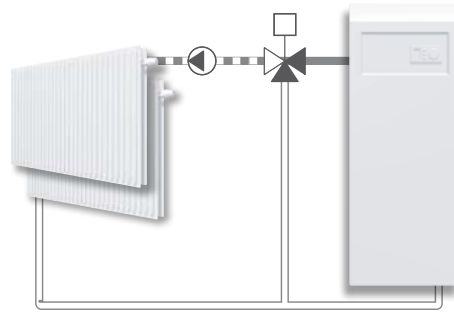
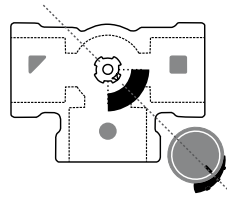

2a

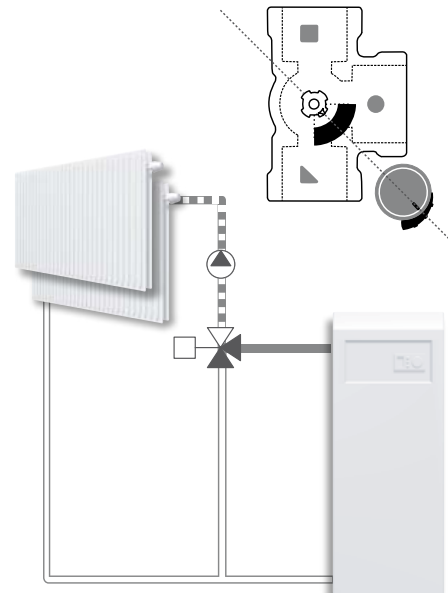

2b

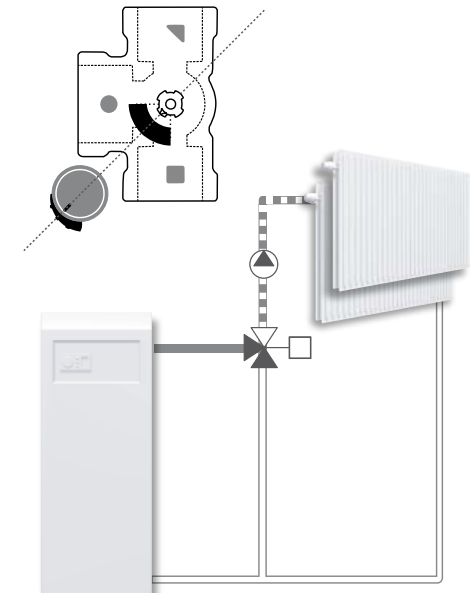

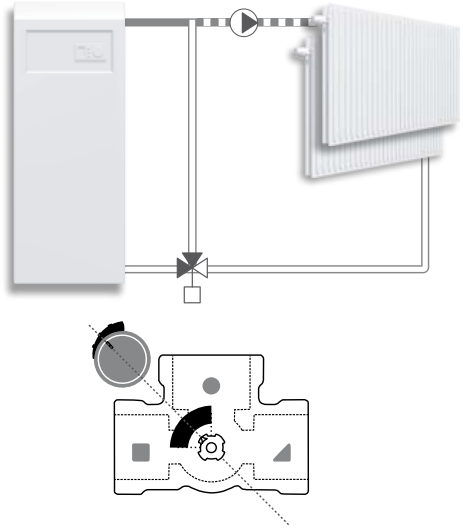
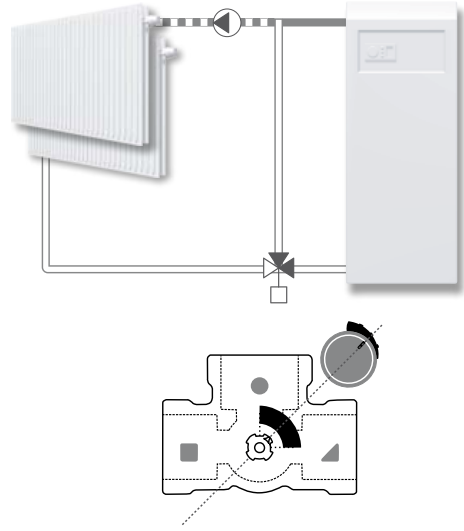
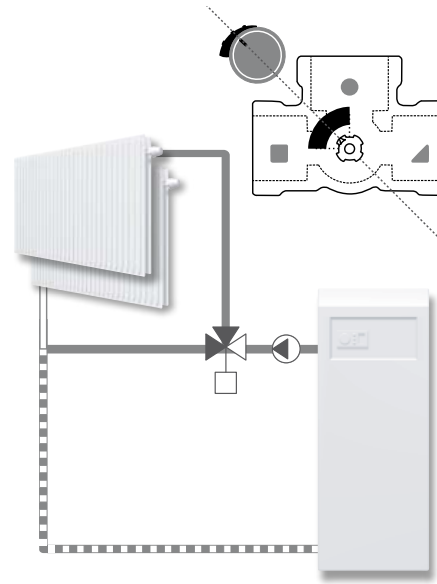
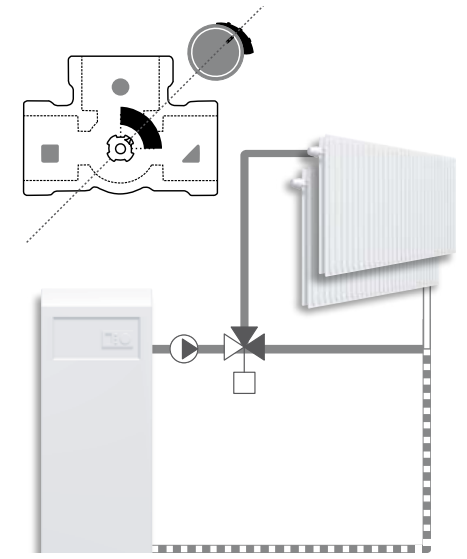
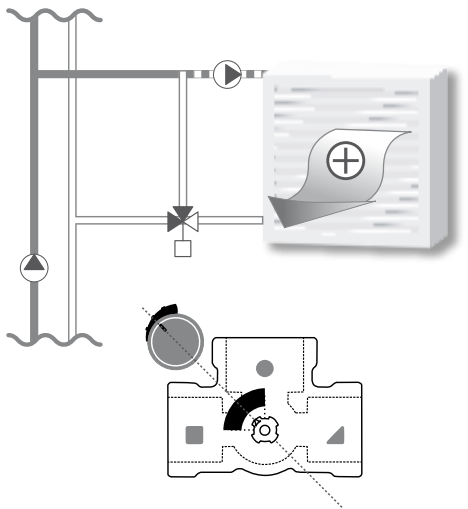
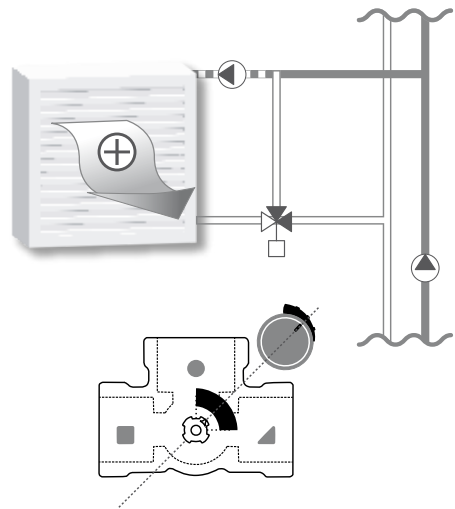
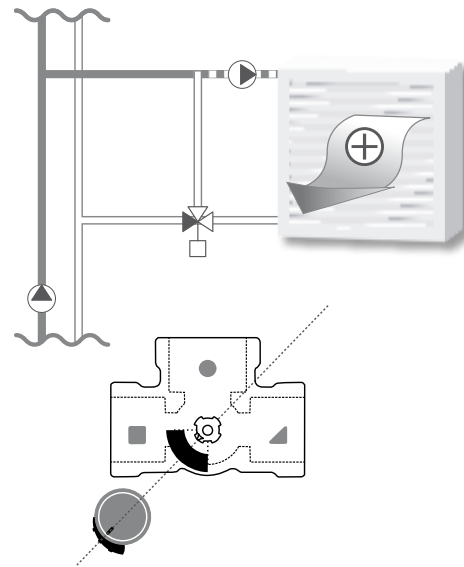
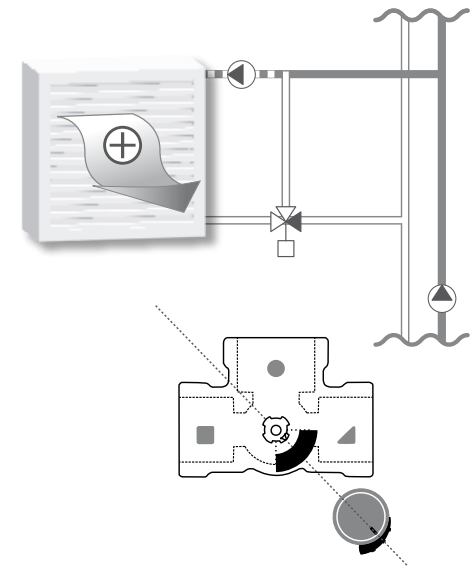
**3a****3b****4a****4b****5a****5b****6a****6b**

7a

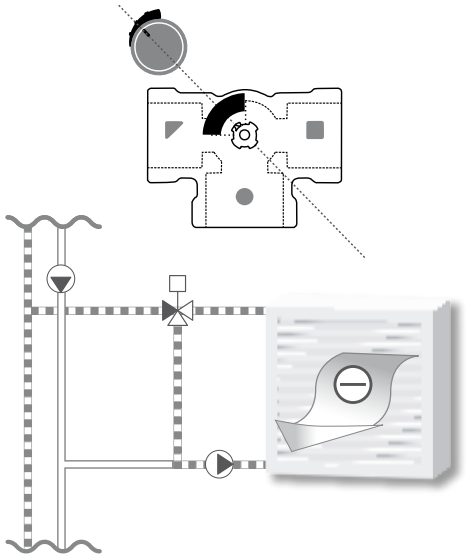

7b

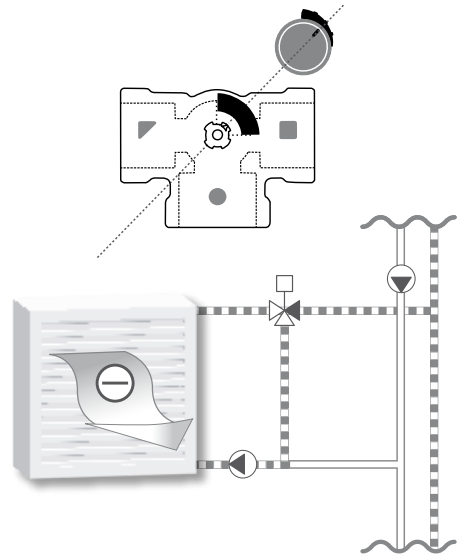

8a

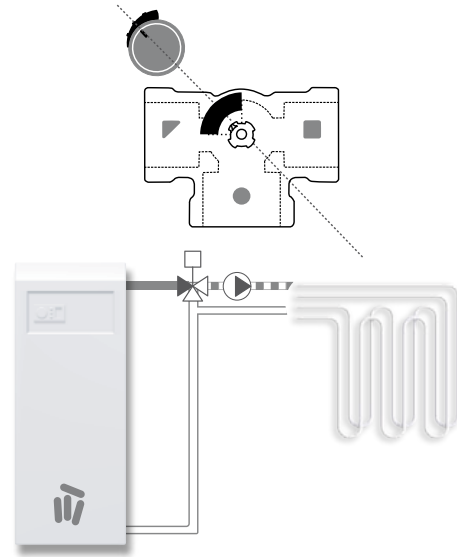

8b

